

SUSPENDED CORNER 90°

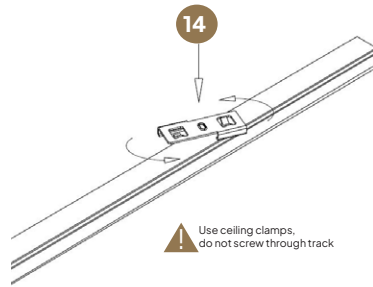

SURFACE

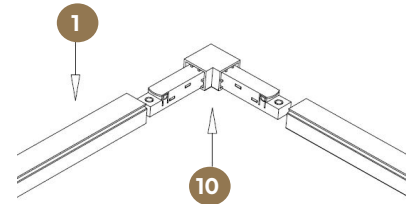

SURFACE CORNER 90°

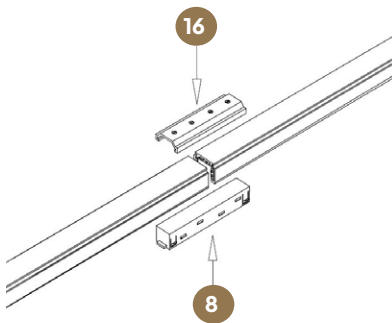

STRAIGHT CONNECTION

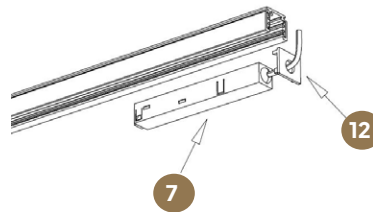

END TRACK

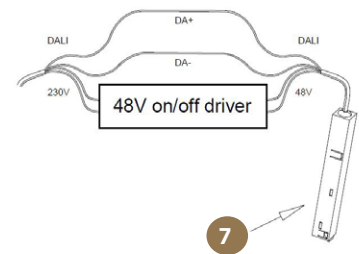

POWER FEED CONNECTION

ACCESSORIES

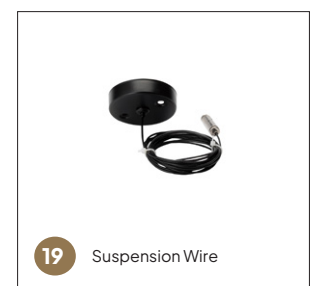
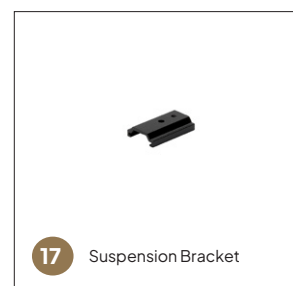
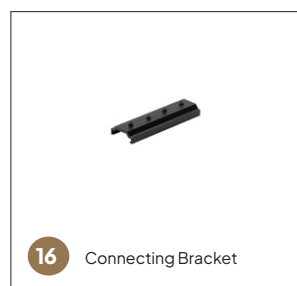
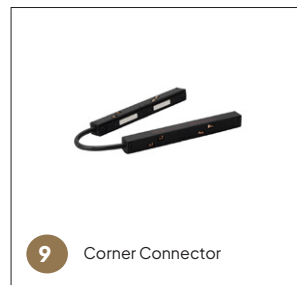
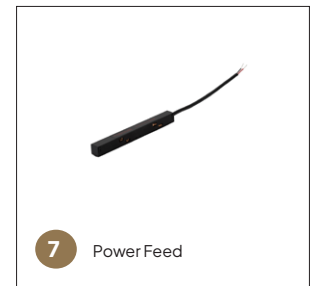
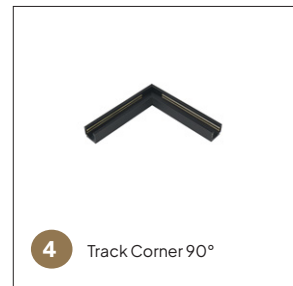
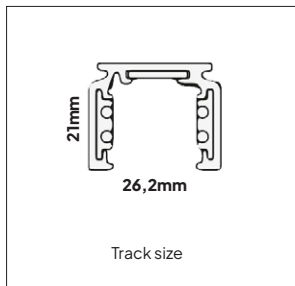



ARTICLE NUMBER	DESCRIPTION	ACCESSORY NUMBER	COLOR
5833.995.99.3	Magnet Track Low Surface 3000mm	1	White
5833.995.99.5	Magnet Track Low Surface 3000mm	1	Black
5850.995.99.3	Magnet Track Corner 90° Low	4	White
5850.995.99.5	Magnet Track Corner 90° Low	4	Black
5833.999.99.5	Magnet Track Blind Cover 1500mm		Black
5852.998.99.3	Magnet Power Feed incl. 3000mm cable	7	White
5852.998.99.5	Magnet Power Feed incl. 3000mm cable	7	Black
5854.998.99.3	Magnet Straight Connector	8	White
5854.998.99.5	Magnet Straight Connector	8	Black
5853.998.99.3	Magnet Corner Connector	9	White
5853.998.99.5	Magnet Corner Connector	9	Black
5851.995.99.3	Magnet L-connector Low W (Outside corner)	10	White
5851.995.99.5	Magnet L-connector Low (Outside corner)	10	Black
5864.995.99.3	Magnet End Cap Low	12	White
5864.995.99.5	Magnet End Cap Low	12	Black
5865.995.99.3	Magnet Ceiling Clamp Low	14	White
5865.995.99.5	Magnet Ceiling Clamp Low	14	Black
5867.995.99.3	Magnet Connecting Bracket Low	16	White
5867.995.99.5	Magnet Connecting Bracket Low	16	Black
5866.995.99.3	Magnet Suspension Bracket Low	17	White
5866.995.99.5	Magnet Suspension Bracket Low	17	Black
5888.995.99.3	Magnet Suspension Wire with quick release Clamp 3000mm	19	White
5888.995.99.5	Magnet Suspension Wire with quick release Clamp 3000mm	19	Black

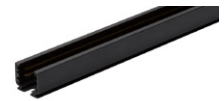



DRIVERS ON/OFF



ARTICLE NUMBER	VOLTAGE	WATTAGE	IP
0148.060.10.0	48VDC	60W	IP67
0148.100.10.1	48VDC	100W	IP67
0148.150.10.1	48VDC	150W	IP67
0148.240.10.0	48VDC	240W	IP67
0148.320.10.0	48VDC	320W	IP67



INTRACK DRIVERS ON/OFF

ARTICLE NUMBER	COLOR	VOLTAGE	WATTAGE	IP
0148.100.40.3	White	48VDC	100W	IP20
0148.100.40.5	Black	48VDC	100W	IP20
0148.250.40.3	White	48VDC	250W	IP20
0148.250.40.5	Black	48VDC	250W	IP20



-  **The 100W InTrack driver is invisible in all Magnet Tracks. The 250W InTrack driver is only invisible in the Magnet Track High and Recessed, in the Low track it's visible for 25mm.**
-  **Full warranty only applies when fixtures are purchased in combination with recommended driver.**